

7

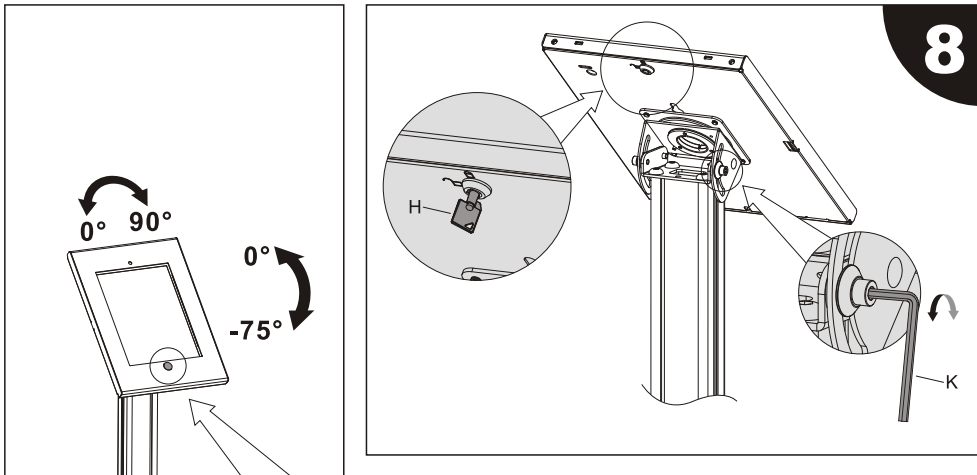

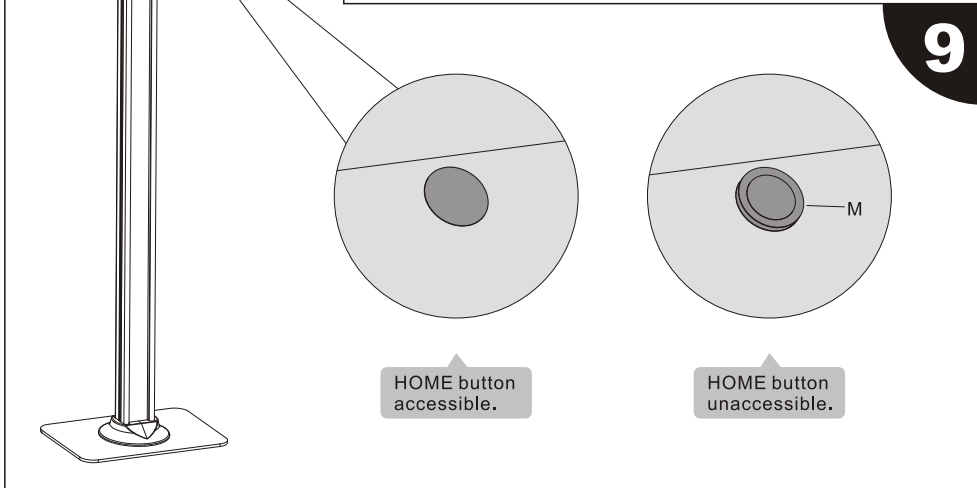







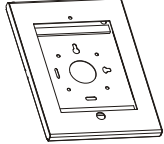

8

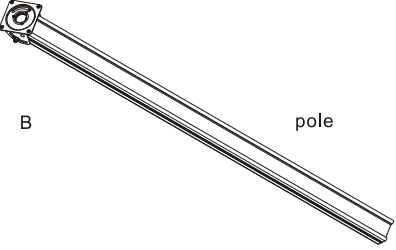
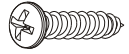
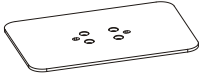

9



Installation Instruction

ITEM	DESCRIPTION/PART NO.	QUANTITY	ITEM	DESCRIPTION/PART NO.	QUANTITY
A	 anti-theft box	1	E	 decorative cover	1
B	 pole	1	F	 ST6.3x55	2
C	 base	1	G	 concrete anchor	2
D	 rubber pad	4	H	 key	2
			I	 M5x6	4
			J	 M8x20	4
			K	 4mm Allen key	1
			L	 5mm Allen key	1
			M	 button	1

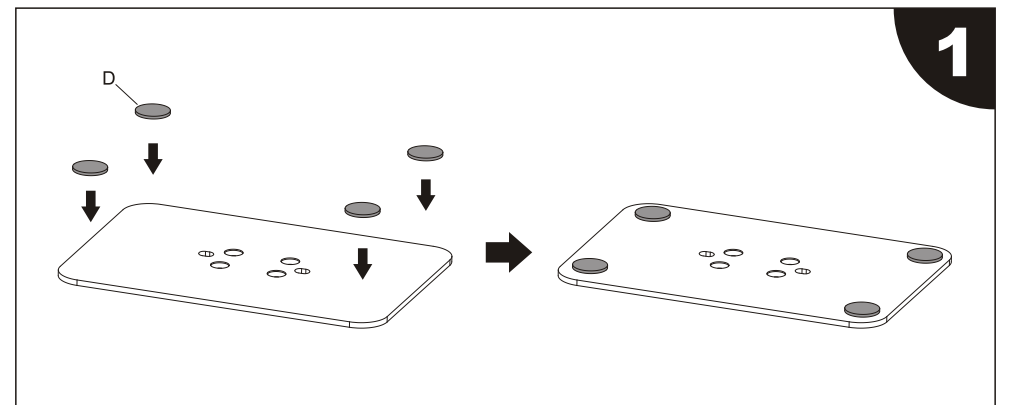

1